



Installation Instructions



**PRODUCT: JK Sway Bar 2012-2015**

REV: B | 07-01-2015 | II-3141

**READ INSTRUCTIONS IN FULL BEFORE INSTALLATION.  
QUESTIONS? CALL 916-631-8071 M-F 7:00 AM – 5:00 PM PST**

The MetalCloak experience includes the ease of installation of our products. We design for most contingencies, but installation may be different based on different Jeep condition, configuration and/or year.

We are continually trying to improve our products and instructions – please help us by providing feedback and pictures if you find any part of the instructions that do not match your particular Jeep or are not easily understandable.

If you have any difficulties at all, please give us a call. Thank you and enjoy your MetalCloak Products!

**IMPORTANT NOTE: We use Stainless Steel Hardware where possible. Therefore, a tube of Silver Anti-seize is provided and should be used on all bolts—only a small amount is needed.**

**WARRANTY INFORMATION:** This article is sold without warranty expressed or implied. No warranty or representation is made as to this products ability to protect the user from injury or death. The user assumes that risk. The effectiveness, warranty and longevity of this equipment are directly related to the manner in which it is INSTALLED, USED and/or MAINTAINED. THE USER ASSUMES ALL RISK. By purchasing this product and opening the packaging, purchasers expressly acknowledge, understand and agree that they take, select and purchase these MetalCloak products from Armored Works, LLC, its affiliates and distributors and agents as is and with all faults. The entire risk as to the quality and performance of these MetalCloak products is with the purchaser. Working on your vehicle can be a dangerous activity. If you are unsure of what you are doing, please leave mechanical or safety critical work to a skilled mechanic. We take no responsibility for the incorrect use and/or installation of MetalCloak products.

## Section 1: Tools & Notes on Installation



**Tools Required:** This list is the recommended tools for ease of installation. Other versions of the same tool can be used. For example, Allen Wrenches instead of Allen Drive Sockets.



Ratchet

15mm socket  
16mm socket  
19mm socket



WD-40

**HOW TO USE THIS GUIDE:** The installation guide contains ALL steps for installation. Please read and follow the instructions in order of each page top to bottom, and left to right.

**Jeep Model:** Instructions may apply to multiple Jeep models, but are labeled separately where appropriate (i.e. TJ vs. LJ).

**Options:** Because of the number of component options we offer, these instructions may contain steps that will not match your particular configuration. You can skip these steps.

**Images:** Pictures are provided and parts are labeled throughout the instructions. Each text box contains guidance based on the pictures next to it. The text will refer to alphabetical labels (A, B, etc.) found in the images.

**Installation Notes:** Terms may be used in the body of the instructions that you may not be familiar with, if you have any questions feel free to contact us at the number below, or email [techhelp@metalcloak.com](mailto:techhelp@metalcloak.com)

**QUESTIONS:** Any questions or comments about the instructions? Call us at 916-631-8071 M-F 7:00 AM – 5:00 PM PST.

## Section 2: Product Components

DC-0001 REV A

SHEET 1 OF 1

ITEM	PART NUMBER/DESCRIPTION	QTY
1	CP-3605 CUSTOM BOLT, SWAY BAR ROTATION	1
2	FA-0050 WASHER, .39ID X .63OD X .06TH SS	1

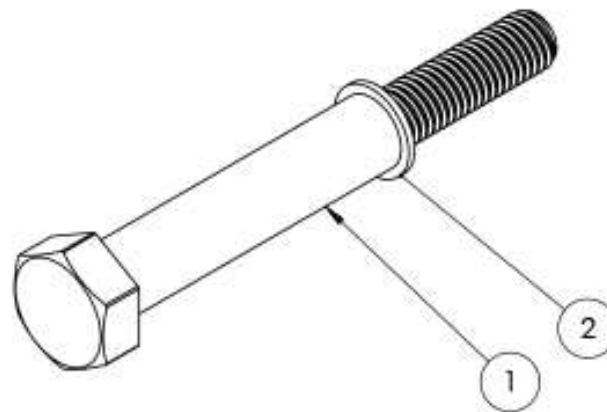

A	<b>TOLERANCES UNLESS OTHERWISE SPECIFIED</b>					THE INFORMATION CONTAINED ON THIS DRAWING IS THE EXCLUSIVE PROPERTY OF ARMORED WORKS, LLC. UNAUTHORIZED REPRODUCTION IS PROHIBITED. <b>DO NOT SCALE DRAWING</b>	 A DIVISION OF ARMORED WORKS, LLC
	DIMENSIONS ARE IN INCHES ANGLES ARE 90 DEG UNLESS OTHERWISE SPECIFIED	DECIMAL .XX +/- .010 .XXX +/- .005	FRACTION +/- 1/16	ANGULAR +/- 1 DEG	SURFACE 32		

## Section 3: Installation Instructions



### Step 1: Preparation for Sway Bar

**Note:** *These instructions are only for 2012-2015 JK Wrangler. Installation of the MetalCloak JK Wrangler Sway Bar is different for 2007-2011 JK Wranglers. If you have a 2007-2011 JK Wrangler go to [www.metalcloakinstructions.com](http://www.metalcloakinstructions.com) and find the 2007-2011 MetalCloak JK Sway Bar installation instructions.*

## Section 3: Installation Instructions

### Step 1: Preparation for Sway Bar

- A. Using a 15mm socket remove the stabilization bolt that connects the rubber retaining grommet to the sway bar housing. The stabilization bolt will not be used again.
- B. Remove housing bolt using a 15mm socket.
- C. Using a 16mm socket loosen and lower the sway bar. This will allow you to rotate the sway bar housing into its new orientation.

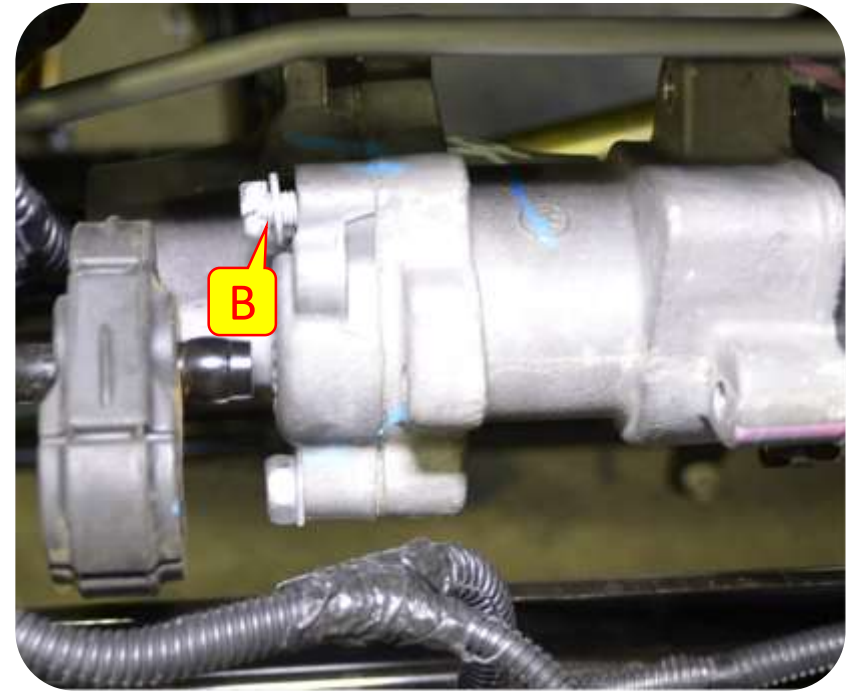
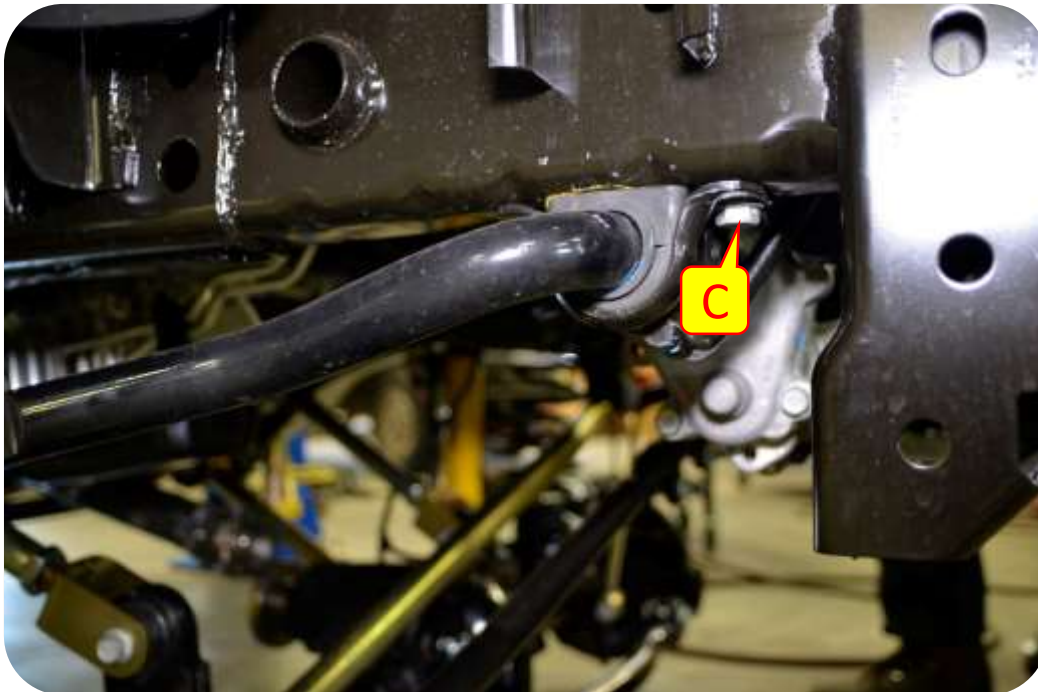
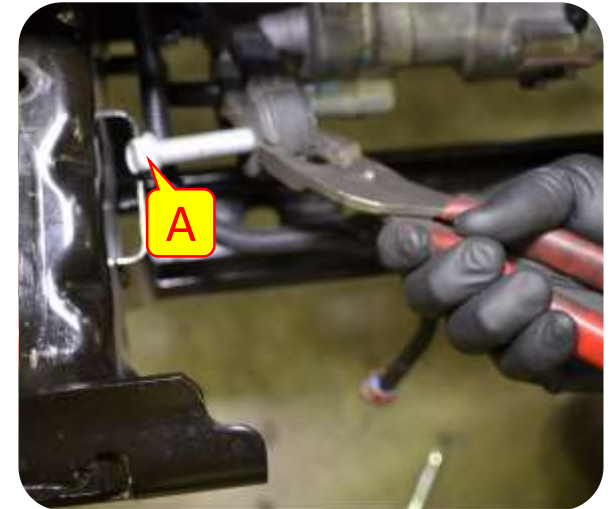

## Section 3: Installation Instructions

### Step 2: Install Sway Bar



- D. Disconnect the sway bars electronic connection plug.
- E. Slide aluminum tube back in plastic clips for needed space.
- F. Rotate the sway bar housing upward to its new orientation.
- G. Reconnect the sway bars electronic connection plug after the sway bar housing is in its new position.

**Note:** You may want to place your bumper on the frame after orientating the sway bar housing to make sure you have clearance for your bumper.

## Section 3: Installation Instructions

### Step 2: Install Sway Bar

- H. Insert the MetalCloak Sway Bar bolt into the rubber retaining grommet that the stabilization bolt was located.
- I. Once the new bolt is through the rubber grommet slip the given washer over the threads of the new bolt.
- J. Using a 19mm socket thread the sway bar bolt through the sway bar housing hole that the old sway bar housing bolt was located.
- K. Tighten new sway bar bolt.
- L. Re-Install Sway Bar.

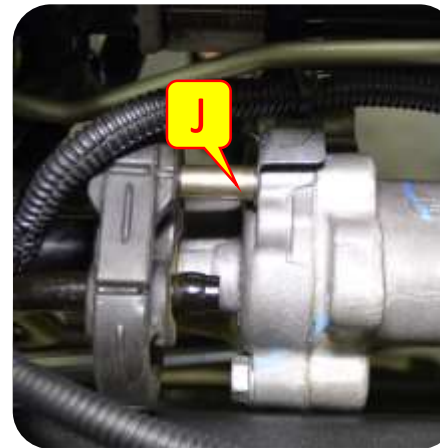
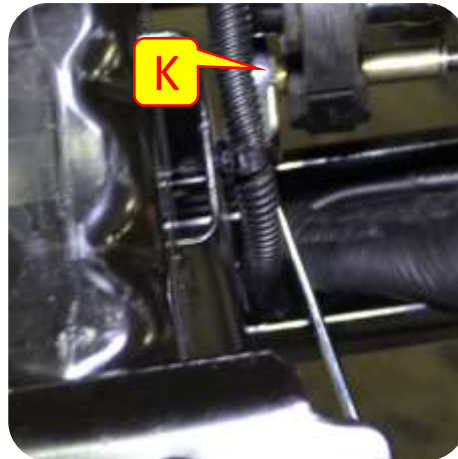
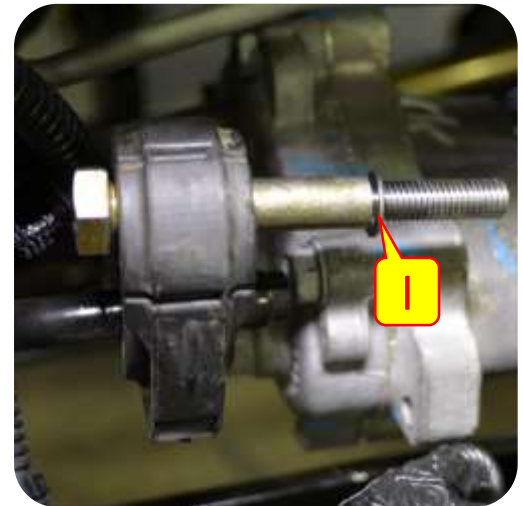
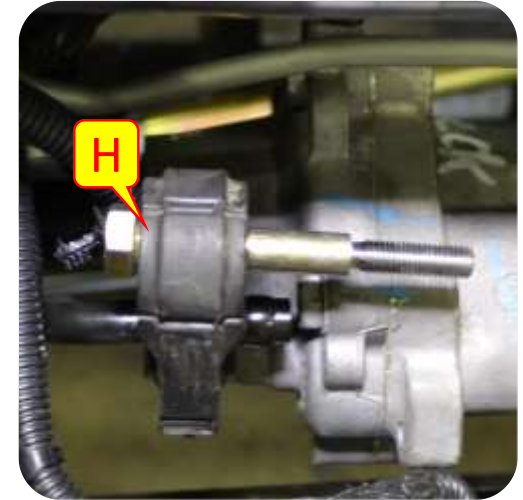

**Note:** Spray WD-40 into the rubber retaining grommet hole for easier installation of the sway bar bolt.