



PRODUCT: JL Rear Full Width Bumper

REV: A | 06/03/2019 | II-6941

READ INSTRUCTIONS IN FULL BEFORE INSTALLATION.
QUESTIONS? CALL 916-631-8071 M-F 7:00 AM – 5:00 PM PST

The MetalCloak experience includes the ease of installation of our products. We design for most contingencies, but installation may be different based on different Jeep condition, configuration and/or year.

We are continually trying to improve our products and instructions – please help us by providing feedback and pictures if you find any part of the instructions that do not match your particular Jeep or are not easily understandable.

If you have any difficulties at all, please give us a call. Thank you and enjoy your MetalCloak Products!

IMPORTANT NOTE: We use Stainless Steel Hardware where possible. Therefore, a tube of Silver Anti-seize is provided and should be used on all bolts—only a small amount is needed.

WARRANTY INFORMATION: This article is sold without warranty expressed or implied. No warranty or representation is made as to this products ability to protect the user from injury or death. The user assumes that risk. The effectiveness, warranty and longevity of this equipment are directly related to the manner in which it is INSTALLED, USED and/or MAINTAINED. THE USER ASSUMES ALL RISK. By purchasing this product and opening the packaging, purchasers expressly acknowledge, understand and agree that they take, select and purchase these MetalCloak products from Armored Works, LLC, its affiliates and distributors and agents as is and with all faults. The entire risk as to the quality and performance of these MetalCloak products is with the purchaser. Working on your vehicle can be a dangerous activity. If you are unsure of what you are doing, please leave mechanical or safety critical work to a skilled mechanic. We take no responsibility for the incorrect use and/or installation of MetalCloak products.

Section 1: Tools & Notes on Installation



Tools Required: This list is the recommended tools for ease of installation. Other versions of the same tool can be used. For example, Allen Wrenches instead of Allen Drive Sockets.



Socket & Ratchet Wrench

8MM Socket 16MM Socket
21MM Socket 22MM Socket
3/4 Socket



5/16" Allen Wrench
5/32" Allen Wrench

Phillips Screwdriver



Mallet

9/16 Box Wrench



HOW TO USE THIS GUIDE: The installation guide contains ALL steps for installation. Please read and follow the instructions in order of each page top to bottom, and left to right.

Jeep Model: Instructions may apply to multiple Jeep models, but are labeled separately where appropriate (i.e. TJ vs. LJ).

Options: Because of the number of component options we offer, these instructions may contain steps that will not match your particular configuration. You can skip these steps.

Images: Pictures are provided and parts are labeled throughout the instructions. Each text box contains guidance based on the pictures next to it. The text will refer to alphabetical labels (A, B, etc.) found in the images.

Installation Notes: Terms may be used in the body of the instructions that you may not be familiar with, if you have any questions feel free to contact us at the number below, or email techhelp@metalcloak.com

QUESTIONS: Any questions or comments about the instructions? Call us at 916-631-8071 M-F 7:00 AM – 5:00 PM PST

Section 1: Tools & Notes on Installation

DC-0001 REV A

SHEET 1 OF 1

	1	2	3	4	5	6	7	8
ITEM	PART NUMBER/DESCRIPTION			QTY.				
1	6901 REAR BUMPER BASE, JL			1				
2	6902 REAR STOCK CAPS, JL			1				

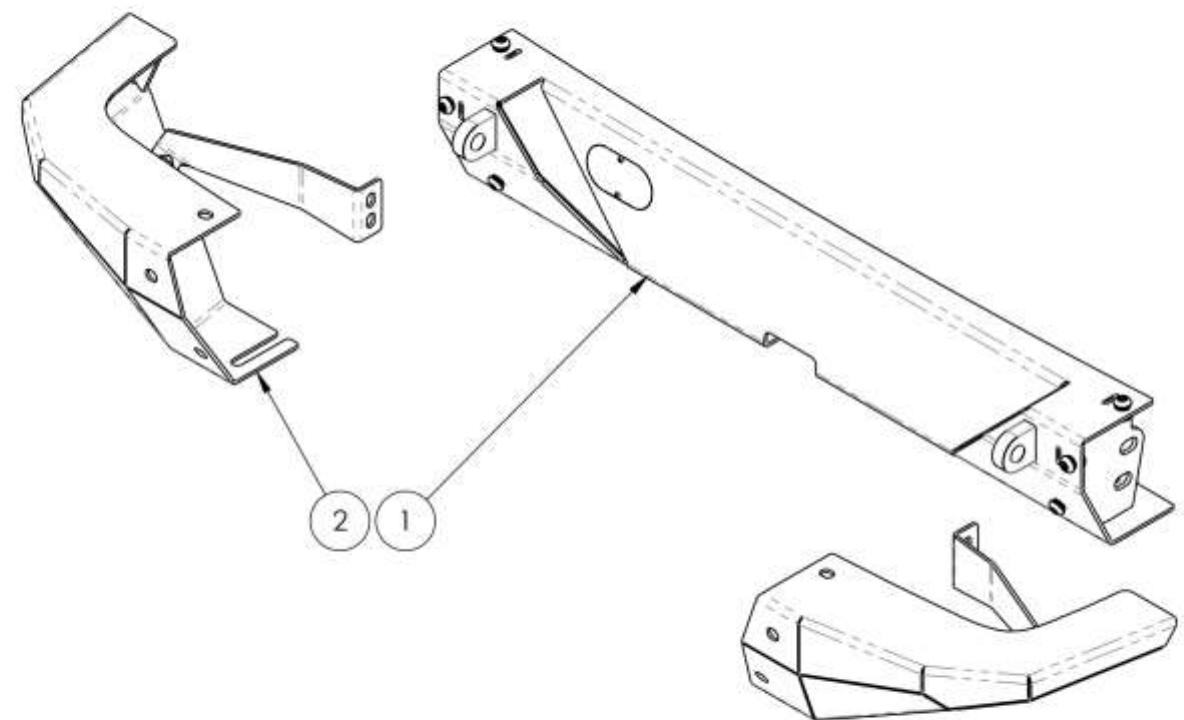

THE INFORMATION CONTAINED ON THIS DRAWING IS THE EXCLUSIVE PROPERTY OF ARMORED WORKS, LLC. UNAUTHORIZED REPRODUCTION IS PROHIBITED.

DO NOT SCALE DRAWING

PART NUMBER/DESCRIPTION **MetalCloak**
A DIVISION OF ARMORED WORKS, LLC

6941 BUMPER KIT, STOCK CAPS, JL

Section 2: Installation Instructions

Step 1: Remove Stock Bumper

A. Remove the spare tire.

Note: If you are removing the stock spare tire use a 22mm socket.

B. Using a 8mm socket wrench remove the 3 bolts in the rear fender well plate.

C. Using a 16mm socket wrench remove the rear bumper mounting brackets. Save the 2 bolts on each side that were attached to the frame.

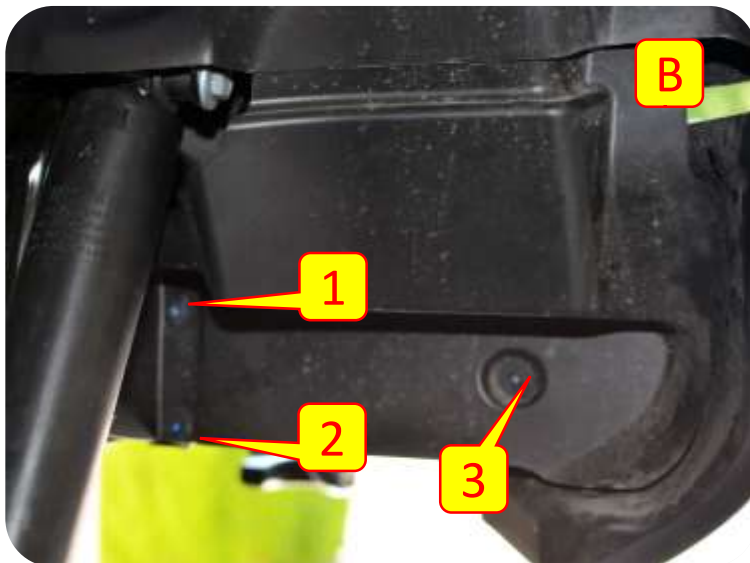
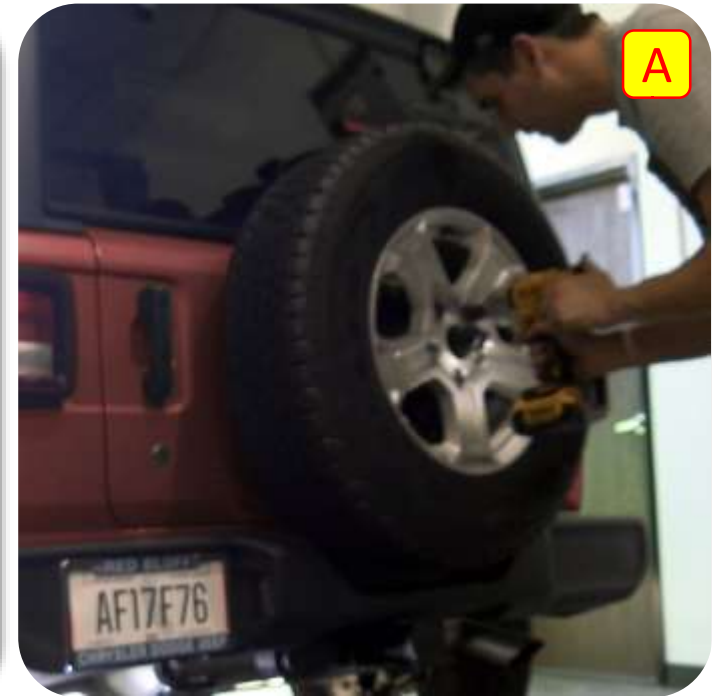

Section 2: Installation Instructions

Step 1: Remove Stock Bumper

- D. Disconnect the license plate light plug from the wiring harness and by removing the plastic tree clips.
- E. Using a 16mm socket wrench remove the rear bumper bolts. Save the 2 bumper bolts at the frame.
- F. Remove the Rear Bumper.

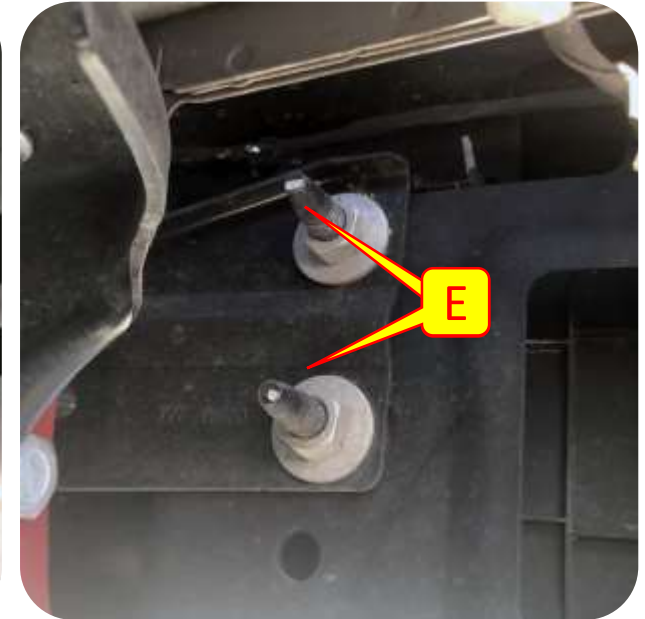

Section 2: Installation Instructions

Step 1: Remove Stock Bumper

G. Using a 21mm socket wrench remove the rear bumper brackets located on the frame. **Save Bolts.**

H. Using a 21mm socket remove the tow hook.

I. Thread in the lower bumper bolts until the threads are flush with the weld nut. Using a rubber mallet hit the bolt head to disconnect the weld nut from the frame.

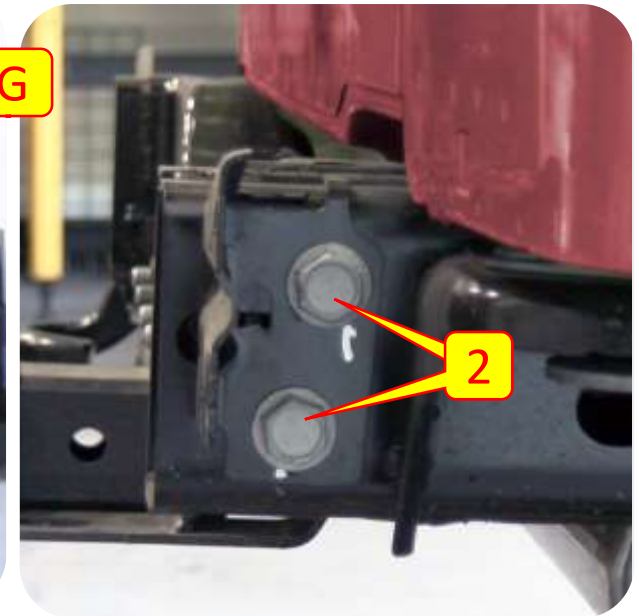
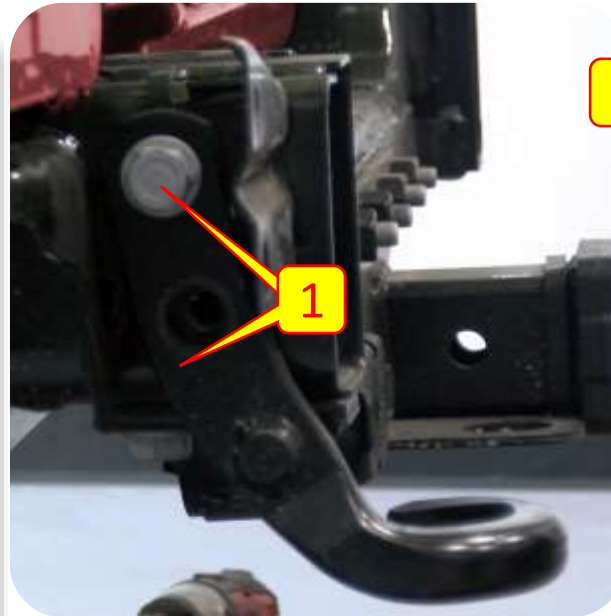

Section 2: Installation Instructions

Important Note: *If your bumper comes with the tow hitch bracket seen below. This bracket will be replaced with the 2 M12 nuts provided for the tow hitch.*



Section 2: Installation Instructions

Step 2: Removing Tow Hitch Wiring Harness

- J. If you have the tow wiring option use a 16mm socket to disconnect the two bolts located on the stock tow wiring skid. **Save the two bolts.**
- K. Disconnect the tow wiring harness.
- L. Remove the tow wiring face plate from the stock skid by pressing the two metal clips.
- M. disconnect the tree clips on the tow wiring harness from the cross member.
- N. Disconnect the plug on the passenger side and remove the wiring harness from the jeep. **Save the wiring harness.**

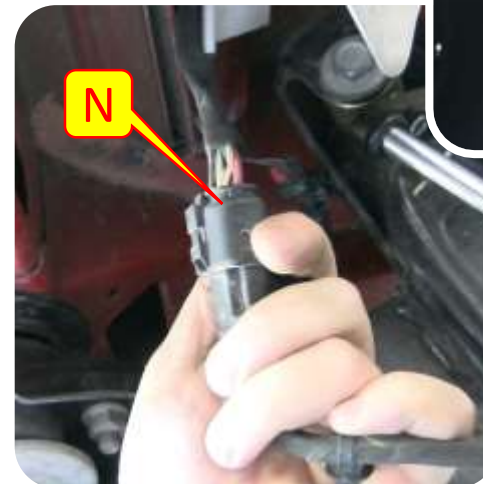
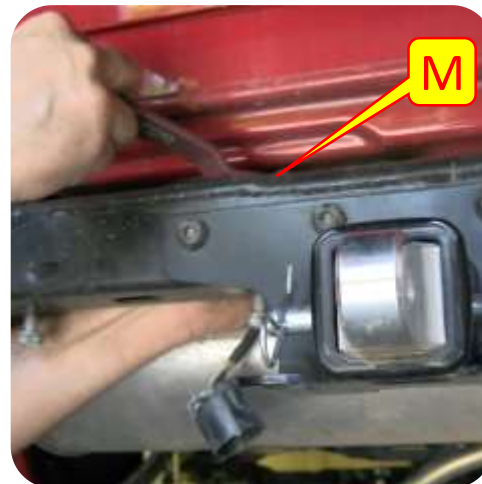

Section 2: Installation Instructions

Step 3: Tow Hitch Wiring Harness Installation

- O. If you have the tow hitch package install the tow hitch plug into the hole located on your MetalCloak rear bumper. If you do NOT have the tow hitch package install the provided block off plate using the self tapping screws.
- P. If you have the tow hitch package attach the wiring harness to the tow hitch plug.
- Q. Install the provided bumper nut plate into the frame rail where the weld nuts were removed (Step I).

Note: *The nut plates are specific to the passenger and driver side, double check to make sure the nut plates line up with the factory holes.*

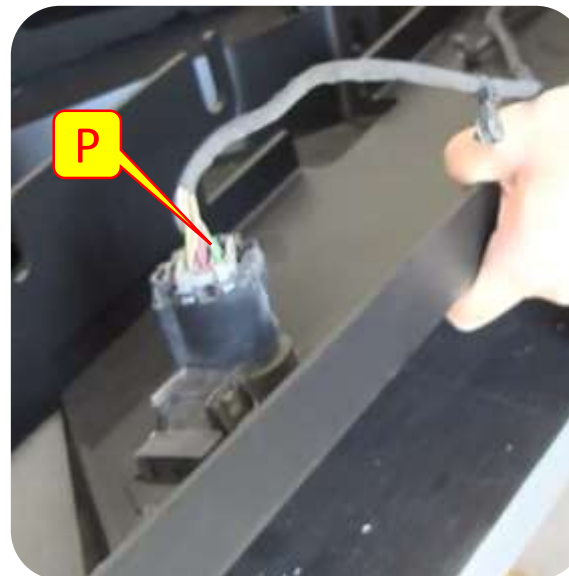

Section 2: Installation Instructions

Step 4: Rear Bumper Base Installation

- R. Install the provided bolts loosely to help hold the rear bumper nut plate into place in preparation for bumper installation.
- S. If you have the tow wiring package, before installing the bumper feed the tow wiring harness through the gap between the crossmember and the tub.
- T. Place the rear bumper into place. MetalCloak recommends using a second pair of hands during the install.

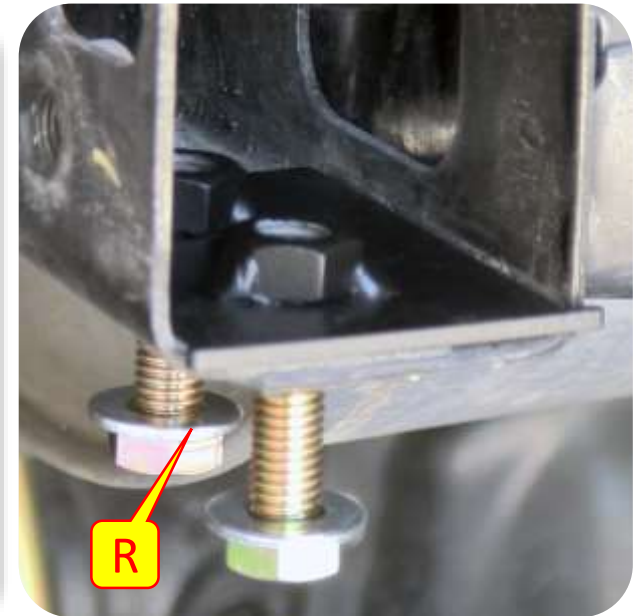

Section 2: Installation Instructions

Step 4: Rear Bumper Base Installation

- U. Using the stock hardware attach the bumper base to the frame. Do not fully tighten
- V. On the underside of the bumper base, Install the provided spacer between the frame rail and the bumper. Make sure the spacer is inserted as far as possible.
- W. Reinstall the two stock tow wiring skid bolts. Do not fully tighten.
- X. If you have the tow wiring package reconnect the tow wiring harness and reinsert the tree clips along the crossmember to help hold the wiring into place.

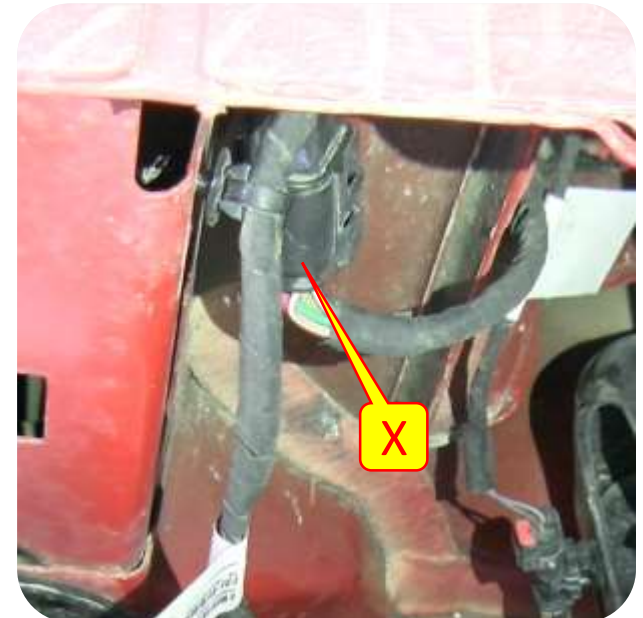
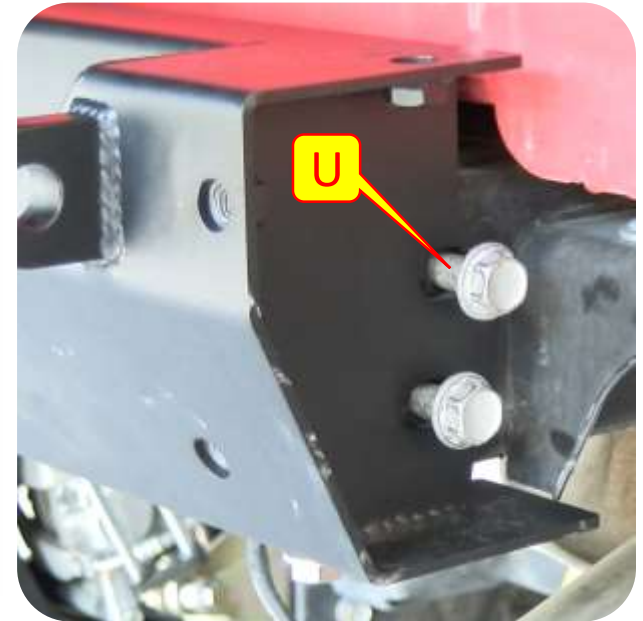

Section 2: Installation Instructions

Step 5: Rear Bumper End Caps Installation

- Y. Install the rear bumper end caps using the provided button head bolts. Make sure the slotted section of the end caps goes between the two bottom bolts located on the bumper base.
- Z. Using a 5/16 allen wrench tighten the button head bolts located on the bumper end caps.
- AA. Align and level the bumper and using a 21mm socket wrench tighten the stock bolts located at the frame rail.

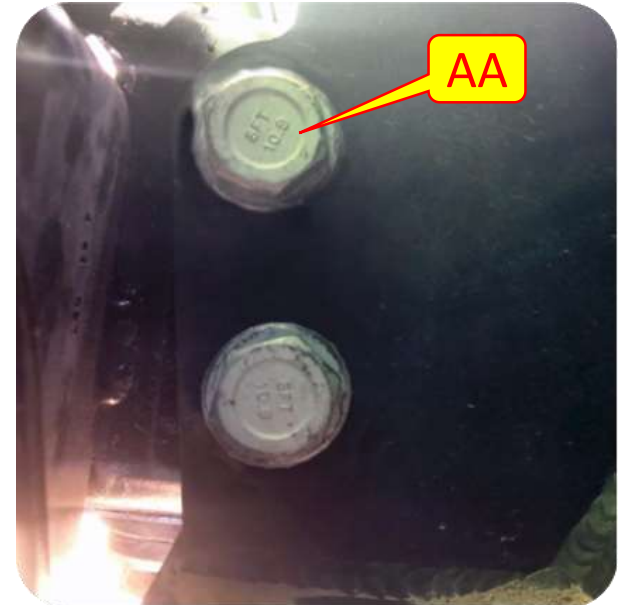
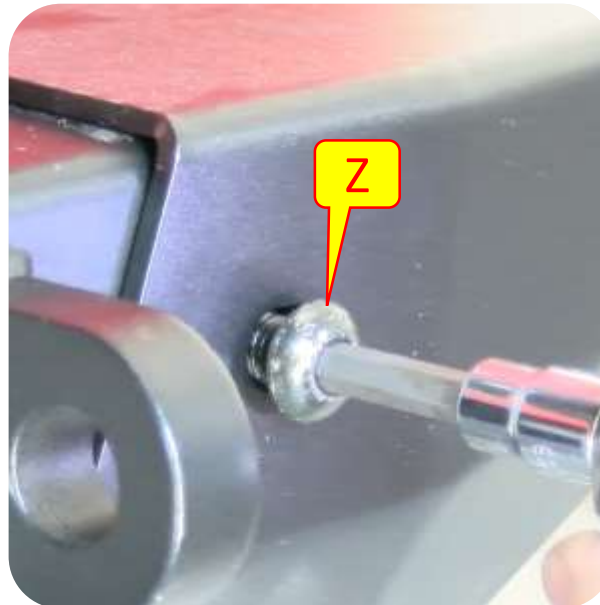

Section 2: Installation Instructions

Step 5: Rear Bumper End Caps Installation

BB. Using a 3/4" socket wrench tighten down the two bolts located on the underside of the end caps.

CC. Using a 16mm socket tighten down the stock tow wiring skid plate bolts.

DD. Using the provided button head bolts, washers, and nylock nuts install the end cap brace loosely to the end cap.

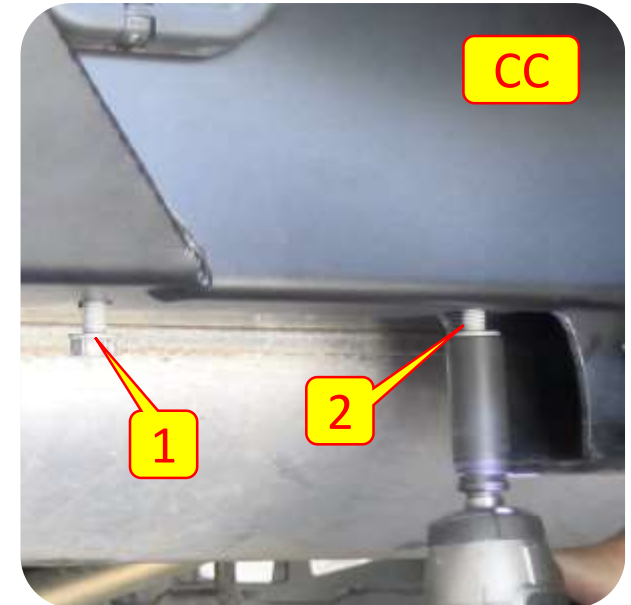

Section 2: Installation Instructions

Step 5: Rear Bumper End Caps Installation

- EE. Using the stock bolts install the end cap support bracket at the frame. Tighten with a 16mm socket wrench
- FF. Using a 5/32 allen wrench and a 9/16 socket tighten the end cap support bracket button head bolts attached to the end cap.
- GG. Make sure all hardware is fully tightened.

